



WIPLINE FLOATS • SKIS • MODIFICATIONS • AIRCRAFT SALES
AVIONICS • INTERIOR • MAINTENANCE • PAINT REFINISHING

INSTRUCTIONS FOR CONTINUED AIRWORTHINESS

FOR AN

EXECUTIVE INTERIOR INSTALLATION

IN

VIKING MODEL DHC-6-200, -300, AND -400 AIRCRAFT

WIPAIRE DOC. NO. 1005649

INCLUDING

**MAINTENANCE MANUAL
AIRWORTHINESS LIMITATIONS
ILLUSTRATED PARTS REFERENCE**

REG. NO. _____

SER. NO. _____

1700 Henry Ave – Fleming Field (KSGS), South St. Paul, MN 55075





Ph: 651.451.1205 Fax: 651.457.7858

www.wipaire.com

**INSTRUCTIONS FOR CONTINUED AIRWORTHINESS
EXECUTIVE INTERIOR INSTALLATION
DHC-6-200, -300, AND -400 TWIN OTTER AIRCRAFT**

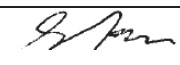
©2010 Wipaire, Inc.
1700 Henry Ave.
So. St. Paul MN 55075

LOG OF REVISIONS

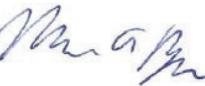
REV. NO.	PAGES	DESCRIPTION	DATE	FAA ACCEPTED*
N/C	ALL	INITIAL DOCUMENT ISSUANCE	2/11/10	
A	ALL	ECO 22131 SEE W056144-34-02 ADDED SEATING CONFIGURATION B	12/2/10	
B	ALL	ECO 22623 SEE W056144-34-03 ADDED SEATING CONFIG. C, "DECRANE" TO "GOODRICH" FOR SUPPLIER NAME CHANGE, REMOVED FIGURES – REPLACED WITH DRAWING REFERENCE	1/18/12	
C	ALL	STC SA02808CH AMENDMENT CHANGED SEATING CONFIGURATION NUMBERING FROM A-C TO 01-03	4/12/13	
D	ALL	CHANGED DOCUMENT NUMBER TO 1005649, ADDED -400 AIRCRAFT, ADDED CONFIGURATIONS -04 THRU -10	3/17/16	
E	ALL	ADDED LAV INSTALL, USB PORT INSTALL, AND COMMISSARY CABINET. REVISION REFLECTS OPENING UP INTERIOR LOPA.	3/29/18	

*Airworthiness Limitations section only Approved by Manager, Chicago Aircraft Certification Office.
NOTE: Revised text is indicated by a vertical black line along left margin.

Current copies of this manual and related installation drawing(s) are available from Wipaire, Inc. 1700 Henry Ave. So. St. Paul MN. Installation drawing 1004310 must be employed with this ICAW. Service letters and additional information is maintained continuously at the website www.wipaire.com.

SECTION 1

MAINTENANCE MANUAL

1. Description

This aircraft has been equipped with an executive seating system and interior per Wipaire, Inc. drawing number 1004310. This seating system installation allows for up to ten (10) each passenger seats and interior amenities between aircraft fuselage stations 111 and 288. This Wipaire, Inc executive seating installation is generally compatible with additional original equipment or aftermarket aft cabin seating systems, which may be installed in the cabin.¹

The Wipaire, Inc. Twin Otter executive seating system approves installation of ten defined seating configurations, -01 thru -10. This seating system is also flexible per the layout of passenger accommodations (LOPA) defined in installation drawing 1004310.

The ten seating configurations are described and shown below.

Configurations -03 and -07 are comprised of two each aft-facing passenger seats only. The aft facing seats are located at stations 166 and 137, RH and LH, respectively.²

See drawing 1004310, latest FAA approved revision for detailed information and depictions of each approved seating configuration, as well as criteria defining options regarding custom interior arrangements.

¹ Ensuring this compatibility is ultimately the responsibility of the STC installer, due to the wide range of cabin systems and seating options available. The installer *must* adhere to the seating and component installation configurations shown in the approved installation drawing(s).

² Seat locations for configuration -03 and -07 are designed to fit around other equipment that may be installed in the aircraft. This manual, and associated approval, applies to the seats *only*, as shown on the installation drawing. The installed executive seats must not interfere with any installed equipment; and any installed equipment must not interfere with any executive seat(s). Refer to your local civil aviation regulations with respect to installation of multiple alterations or STCs on a single airframe.

1.1. Seating Configurations -01 and -05

Seating configuration -01 is comprised of six each club seats with armrests and a three place side facing divan. Interior amenities include two each cabinets for storage, two each folding tables for the aft club positions, a forward cabin sliding door, and an optional aft cabin door. Additional stowage includes drawers underneath the divan seats. Configuration -05 substitutes fixed club seats for swivel seats. Configuration -05 is otherwise identical to configuration -01.

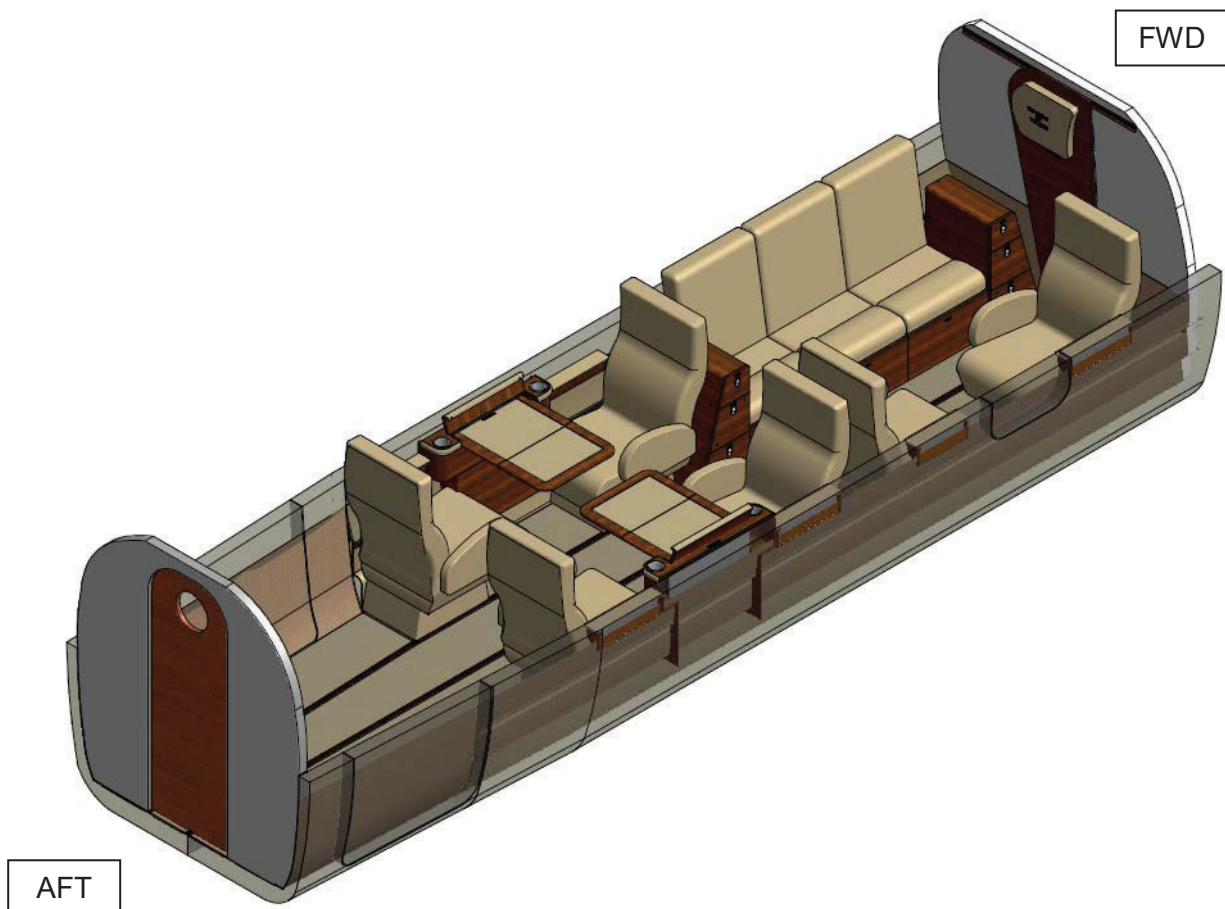

Figure 1 – Seating Configurations -01 and -05 (see drawing 1004310)

1.2. Seating Configuration -02 and -06

Seating configurations -02 is comprised of four each club seats with armrests and two each three-place side facing divans. Interior amenities include two each cabinets for storage, one folding table for the aft club position, a forward cabin sliding door, and an optional aft cabin door. Configuration -06 substitutes fixed club seats for swivel seats. Configuration -06 is otherwise identical to configuration -02.

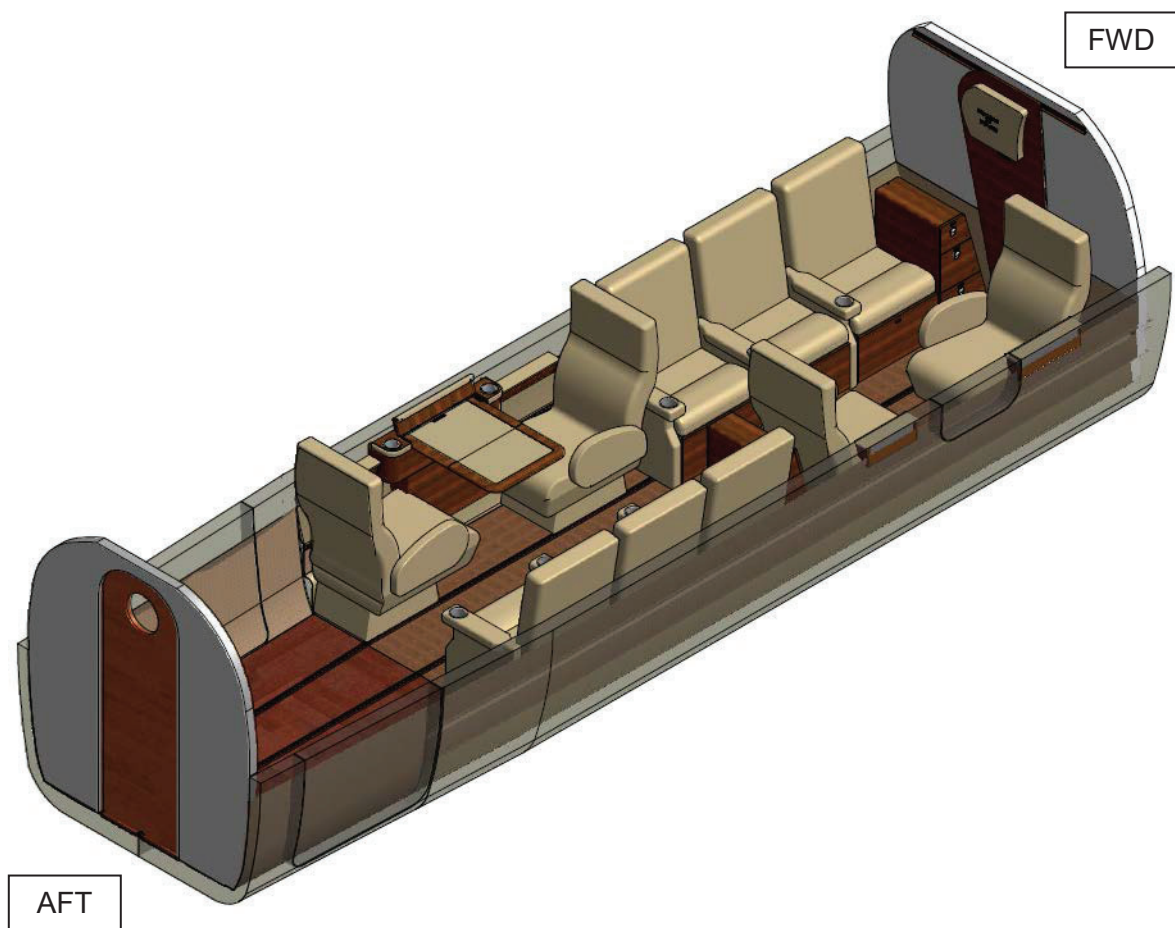

Figure 2 – Seating Configurations -02 and -06 (see drawing 1004310)

1.3. Seating Configurations -03 and -07

Seating configuration -03 is comprised of two each aft facing single seats (*only*) on either side of the aircraft. This seating configuration is approved specifically to facilitate interface with a previously approved medical interior, Transport Canada LSTC C-LSA06-276/D. The seating locations prescribed fit within geometry allowed by the medical interior. Portions of this manual related to cabin amenities (tables, cabinets, etc...) will not apply to this seating configuration; these components are not approved for installation in seating configuration -03. Configuration -07 substitutes fixed club seats for swivel seats. Configuration -07 is otherwise identical to configuration -03.

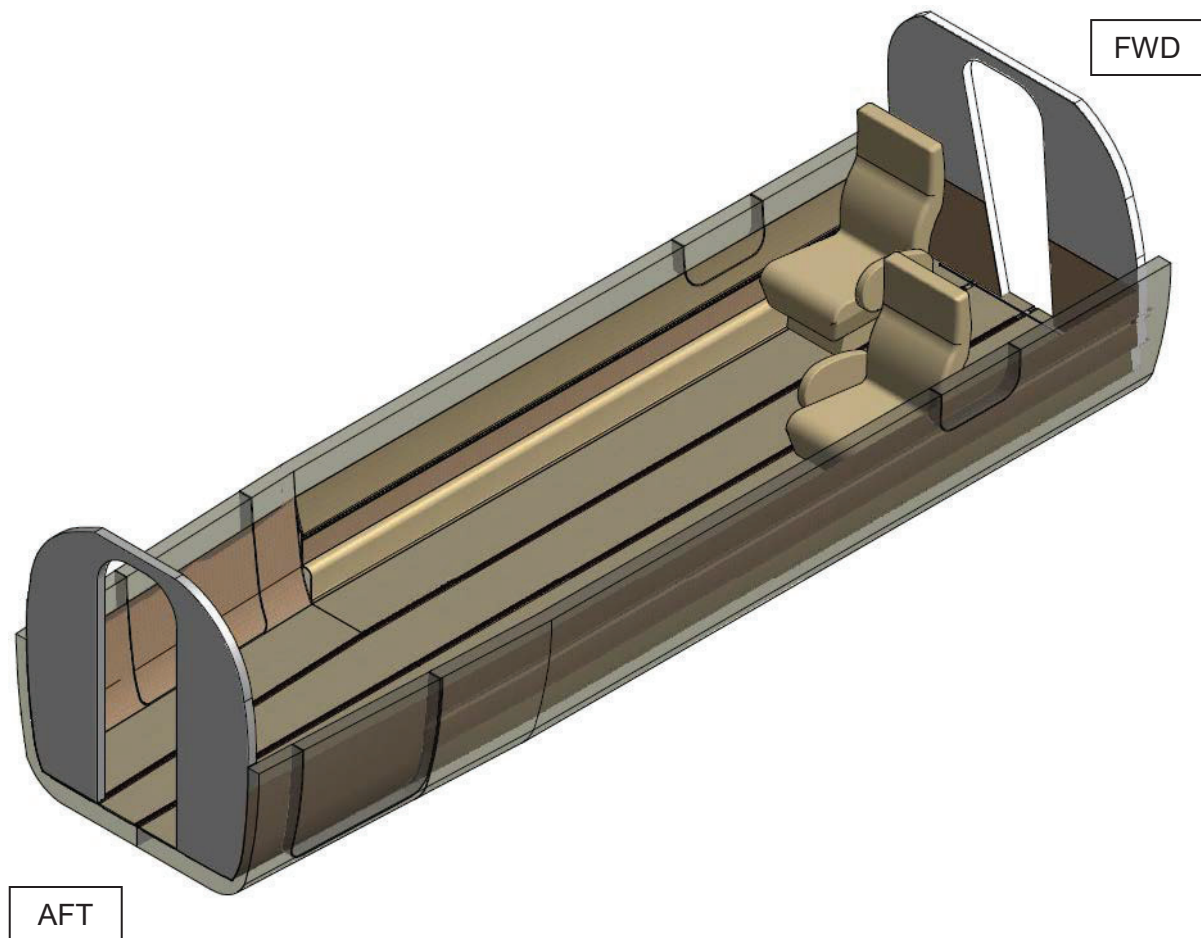

Figure 3 – Seating Configurations -03 and -07 (see drawing 1004310)

1.4. Seating Configuration -04 and -08

Seating configuration -04 is comprised of eight each club seats with armrests. Interior amenities include two each cabinets for storage, two each folding tables for the aft club positions, a forward cabin sliding door, and an optional aft cabin door. Configuration -08 substitutes fixed club seats for swivel seats. Configuration -08 is otherwise identical to configuration -04.

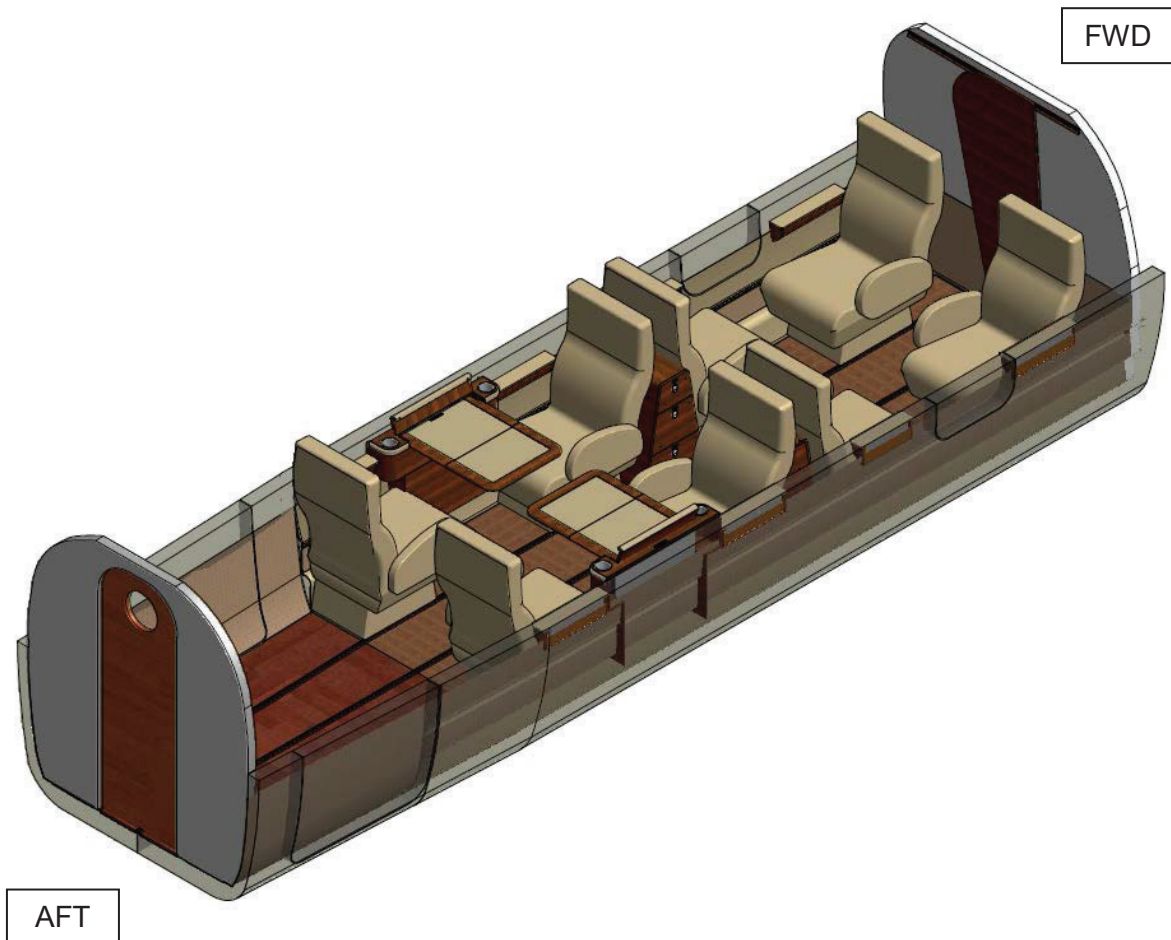

Figure 4 – Seating Configurations -04 and -08 (see drawing 1004310)

1.5. Seating Configuration -09 and -10

Seating configuration -09 is comprised of eight each club seats with armrests. Interior amenities include two each cabinets for storage, a forward cabin sliding door, and an optional aft cabin door. Configuration -10 substitutes fixed club seats for swivel seats. Configuration -10 is otherwise identical to configuration -09.

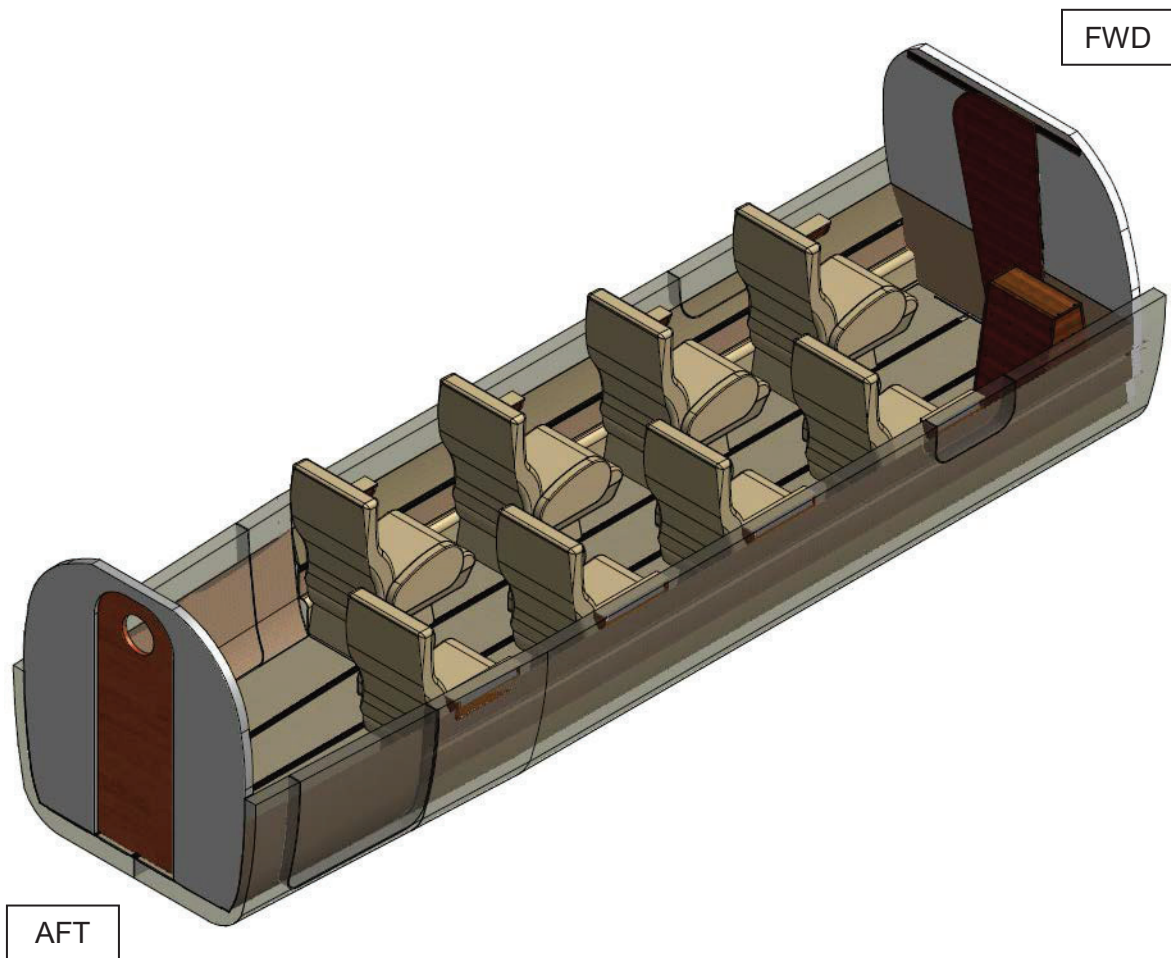

Figure 5 – Seating Configurations -09 and -10 (see drawing 1004310)

1.6. Optional Installations

Optional installations may be added to any of the configurations above.

Aft lavatory installation assembly 1009646 is to be installed in the aircraft cargo compartment aft of STA 332 bulkhead.

Commissary (1009317) may be installed as described in installation drawing 1004310. This particular cabinet and installation only applies to DHC-6-400 aircraft.

USB charging ports may be installed in the aircraft per installation drawing 1009647.

2. Installation/removal

For detailed location, installation and removal specifications for each of the components in all seating configurations, see Wipaire, Inc. drawing number 1004310, latest approved revision, as supplied with your STC kit.

Generally, installation and removal instructions for each of the primary executive interior components are as follows:

Seat installation is performed by

- A. Place the seat in the location specified on drawing number 1004310.
- B. Install the side track seat fittings, separated from the seat, into the aircraft side seat track mount.
- C. Place the bottom seat fittings on the bottom seat track, and engage the locking teeth on the feet, longitudinally positioning the seat in place.
- D. With the bottom feet correctly positioned, and the side seat fitting attached to the side track; use a wrench to slowly move the bottom seat feet up and down, until the side fitting on the seat matches up with the bolt hole on the side track. Slide the side retaining bolt in place and secure with nut. Hardware as provided with seat. Adjustment will have to be made to both the forward and aft seat foot independently, to achieve correct alignment.
- E. After proper alignment has been attained, permanently secure the side and bottom attachment points of the seat.

After installing all seats, before final signoff, double check that all seat-to-airframe attachments, 4 per seat, are secure.

After seats have been adjusted at once, at a given position in the aircraft, they should not require further adjustment when being installed and removed.

Take care to use the above procedure when installing and removing the seats, carefully using the vertical adjustment of the bottom rail attachments achieve proper alignment with the side attachments. Failure to carefully adjust the fit of the seat will make installation and removal considerably more difficult.

Seat removal is accomplished by removing the two side rail seat retaining bolts and nuts, unlocking the bottom seat feet, and removing the seat from the tracks.

Cabinet installation is performed by installing the cargo track hardware on the bottom of the cabinet to the track installed in the aircraft at the location shown on drawing 1004310. Hardware for the cabinet attachment operates much the same as for the seat. Locking ears on the attachment hardware fit in to the seat track, which are then secured with nuts and a knurled fitting. When the cabinet is removed, an additional small section of seat track will remain attached to the honeycomb floor panel.

Forward cabin door installation is accomplished by installing mounting rails on the floor and upper forward bulkhead of the aircraft, to which the cabin door attaches and slides on. Again, see drawing number 1004310 for further details. The lower door rail is screwed

**INSTRUCTIONS FOR CONTINUED AIRWORTHINESS
EXECUTIVE INTERIOR INSTALLATION
DHC-6-200, -300, AND -400 TWIN OTTER AIRCRAFT**

©2010 Wipaire, Inc.
1700 Henry Ave.
So. St. Paul MN 55075

directly into existing nut plates on the floor of the aircraft, one each for each seat track, for a total of three fasteners. The upper door rail is installed using bolts, spacers, and nuts to retain the upper rail to the upper forward cabin bulkhead.

The forward cabin door is easily removed by disassembling the hardware for the top and bottom attachment rails, and then removing the door.

Armrests are installed at each of the club seating locations. The armrests attach to nut plates installed in to a side channel installed in the aircraft fuselage. Armrests may be quickly installed and removed using the screws that retain them to the channel.

Folding table assemblies are bolted and screwed to the side seat track and to the auxiliary channel mount. Each table has a shroud that is retained by cam locks and pins. Two cam locks on the lower edge of the shroud engage vertically oriented pins. To remove the shroud, release the lower cam locks and pull the shroud assembly upward. After the shroud is removed, extend the folding table to gain access to the 4 attachment points to the airframe. Removing the screws and bolts attaching the table assembly to the side seat track and auxiliary channel will allow the table assembly to be removed.

To install the folding table assembly, reattach the bolts and screws retaining the table assembly to the side rail and auxiliary channel. Then place the shroud over the table assembly, aligning the attachment pins. Then tighten the cam locks on the bottom of the shroud to lock the shroud to the attachment pins.

See installation drawing 1009646 for instructions on removing and installing aft lavatory components.

Proper storage and packaging of removed parts and assemblies is critical to ensure damage does not occur during storage or shipping. Honeycomb assemblies such as the armrests, cabin door, and cabinets should be wrapped in a protective plastic coating, and then placed in boxes or crates with protective foam or other packaging to help prevent impact damage. Honeycomb assemblies should be stored in a dry environment.

Storage requirements for upholstered seats may vary depending on the type of upholstery that was employed at the time of installation. Generally, when seats are removed for storage or shipping, they should be placed in a suitably large container with supports to keep the seats from shifting during transportation, the container should have protective padding. Seat assemblies should be stored in a dry environment, to help prevent corrosion.

3. Weight and balance

When seats or other interior components are installed or removed, the aircraft empty weight and balance must be updated to reflect the configuration change.

It is acceptable for components to be added, removed, or relocated from a given seating configuration. For example, in seating configuration -01, it would be acceptable to add, remove, or move any approved seats, cabinets, or table assemblies. When changes are made, all components must be located such that they comply with all applicable LOPA criteria as defined on Wipaire drawing 1004310, latest FAA approved revision. Addition, removal, or relocation of any one or more of the interior components may be desired to accommodate alternate passenger configurations, in combination with other approved seating systems for the aircraft.

Drawing number 1004310 includes a sample empty weight and balance adjustment calculation for defined executive interior installation. Refer to the actual weight and balance update provided with your particular interior installation document package, reflecting the actual change to the empty aircraft weight and balance. Component weights as listed on drawing number 1004310 are approximate and must be exactly weighed during installation due to variations in upholstery. Arm locations on this drawing are accurate relative to the approved center of gravity position for each component.

Drawing number 1004310 also includes station location dimensions for all items of mass installed in accordance with this STC, which match the center of gravity station locations in the drawing tables.

For information on weight and balance for passenger and light cargo loading, see Aircraft Flight Manual Supplement (AFMS) document number W056144-25, latest approved revision. Occupant center of gravity positions are also given for reference on drawing number 1004310.

4. Maintenance instructions

Maintenance for the executive interior seating system approved under this STC is to be performed "on condition."

There are no specific timed interval maintenance tasks for specific components that must be accomplished related to the seating system installation.

Inspection of the interior system components, their security, attachment, and overall condition should be assessed as part of a standard hundred hour interior inspection of the aircraft.

Seat assemblies shall be maintained in accordance with the following manuals, which are approved under the UTC Aerospace seat FAA technical standard order authorization per technical standard order number C39b.

UTC Aerospace Model 160207-1A6, single place side facing divan
Manual number M3005, revision E, 8/12/11, or later approved revision

UTC Aerospace Model 303791-1, fixed single seat, RH arm rest
UTC Aerospace Model 303791-2, fixed single seat, LH arm rest
UTC Aerospace Model 303791-3R2, swiveling single seat
UTC Aerospace Model 303791-4R2, swiveling single seat
Manual number M3113, revision D, dated 2/19/15, or later approved revision

A copy of these manuals is included with your seating system installation package. Additional copies may be obtained by contacting Wipaire.

Seat belt and harnesses shall conform to TSO C114a, and shall be installed per the appropriate manual. Shoulder harnesses for side facing seats *must* be installed with the shoulder harness on the forward side of the seat. Harnesses for forward and aft facing seats *must* be installed on the outboard side of the seat.

Repair of damage to honeycomb structures is not specifically addressed by these maintenance instructions. If, during conditional inspection, structural honeycomb damage to any of the components is noted, contact Wipaire for approved repair or replacement information.

Repair of technical standard order approved seat structure is not specifically addressed by these maintenance instructions. Repair data for seat structure must be specifically FAA approved. Contact Wipaire for further information on repairs to damaged seat structure.

If lavatory assembly 1009646 is installed, refer to Aircraft Technologies, Inc. manufacturer operator's manual for Model 50 Series Clean-Flush aircraft toilet (5000-2A-005). A copy of this manual is included with your lavatory installation package. Additional copies may be obtained by contacting Wipaire.

If USB ports are installed per installation drawing 1009647, refer to Mid-Continent Instrument Co., Inc. manual number 9017942, Rev J (or later revision) or manual number

**INSTRUCTIONS FOR CONTINUED AIRWORTHINESS
EXECUTIVE INTERIOR INSTALLATION
DHC-6-200, -300, AND -400 TWIN OTTER AIRCRAFT**

©2010 Wipaire, Inc.
1700 Henry Ave.
So. St. Paul MN 55075

9017899, Rev E (or later revision) as applicable. A copy of the applicable manual is included with your interior installation package. Additional copies may be obtained by contacting Wipaire.

SECTION 2

AIRWORTHINESS LIMITATIONS

This Airworthiness Limitations section is FAA approved and specifies maintenance required under paragraphs 43.16 and 91.403(c) of the Federal Aviation Regulations unless an alternative program has been FAA approved.

The aircraft Airworthiness Limitations are unchanged as a result of installation of the seating system addressed by this STC.

FAA Approved 
Date: 2/11/10

SECTION 3

ILLUSTRATED PARTS REFERENCE

For a detailed parts breakdown, addressing each component installed for each seating configuration, see Wipaire, Inc. drawing number 1004310, the latest approved revision. This installation drawing includes a detailed Bill of materials for each seating configuration. A current copy of this drawing was supplied with your seat installation paperwork package. Additional copies of this drawing can be obtained by contacting Wipaire, Inc.